

KEY FEATURES

- Designed for compression drivers with 1" (25,4 mm) throat diameter
- Coverage angles of 60° in the horizontal plane and 40° in the vertical plane
- Precise directivity control in the band pass
- Squared and compact design, offering rotatable mounting alternatives
- Heavy-duty reinforced polycarbonate construction
- F.E.M optimized flare



TECHNICAL SPECIFICATIONS ¹

Throat diameter	25,4mm	1 in
Nominal Coverage Horizontal		60°
Nominal coverage Vertical		40°
Directivity Index (DI)	10,5 dB	
Cut-off frequency	1500 Hz	
Material	Reinforced Polycarbonate	

MOUNTING INFORMATION

Dimensions (W x H x D)	160 x 160 x 100 mm
	6,3 x 6,3 x 3,9 in
Cut-out dimensions (W x H)	139 x 139 mm
	5,48 x 5,48 in

Compression driver mounting

Three M5 holes, 120° apart on 57 mm (2,24 in) diameter
Four M5 holes, 90° apart on 76,2 mm (3 in) diameter

Net weight	0,28kg
Shipping weight	0,48kg

DIMENSION DRAWING

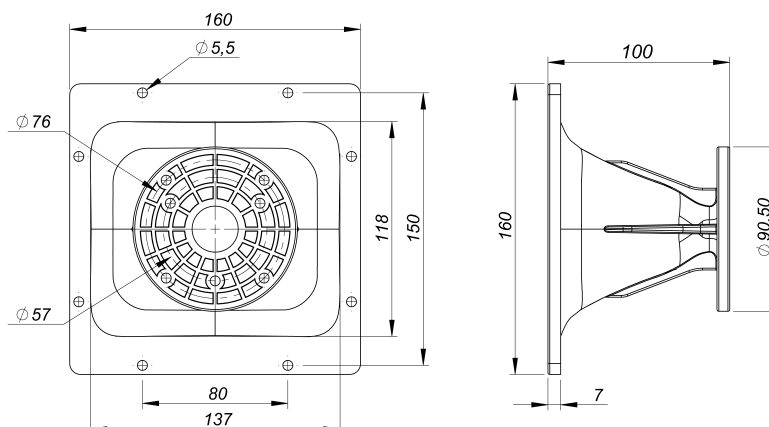

Notes:

¹ Average range 1 - 16 kHz

Horn measured with Beyma CD151Fe/PK compression driver.

HORIZONTAL DIRECTIVITY MAP

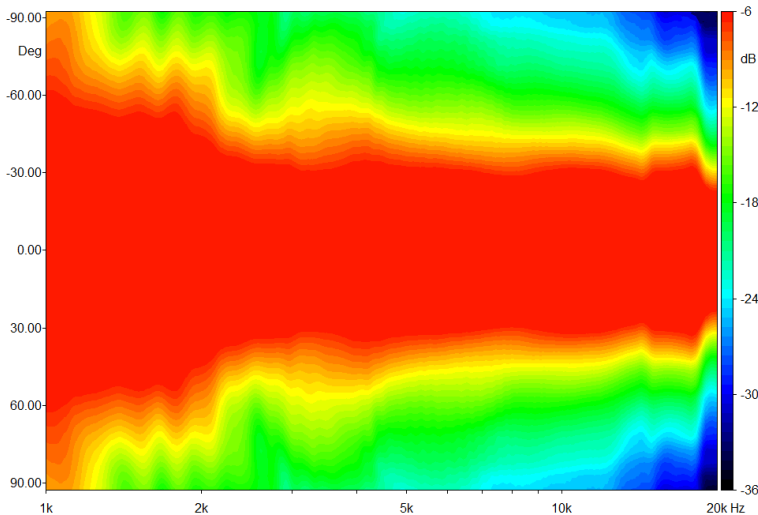

VERTICAL DIRECTIVITY MAP

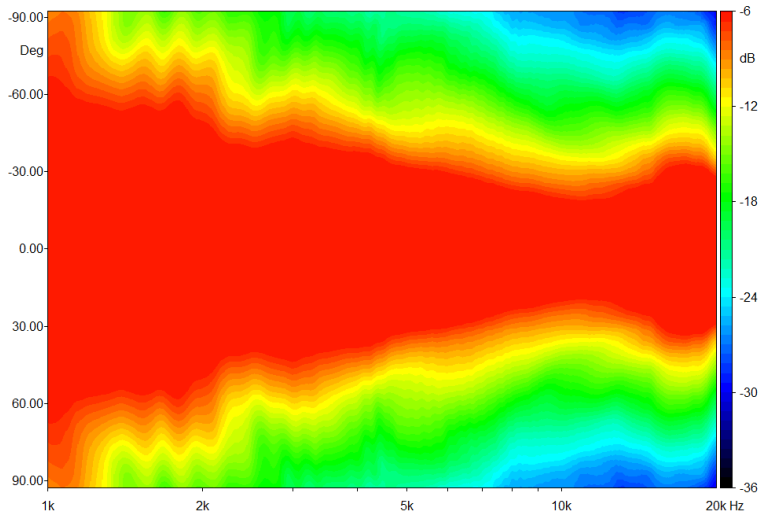

-6 dB BEAMWIDTH

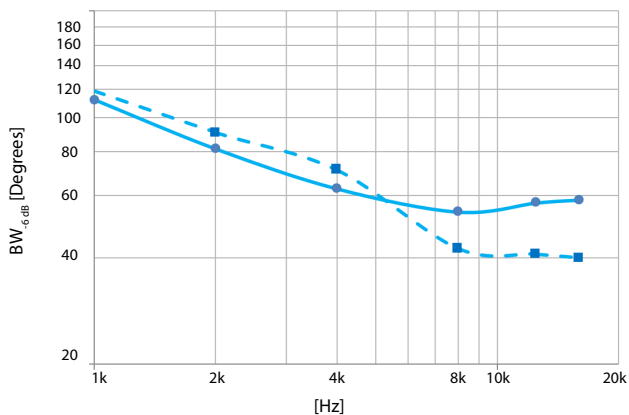

— Horizontal - - - - Vertical

DIRECTIVITY INDEX

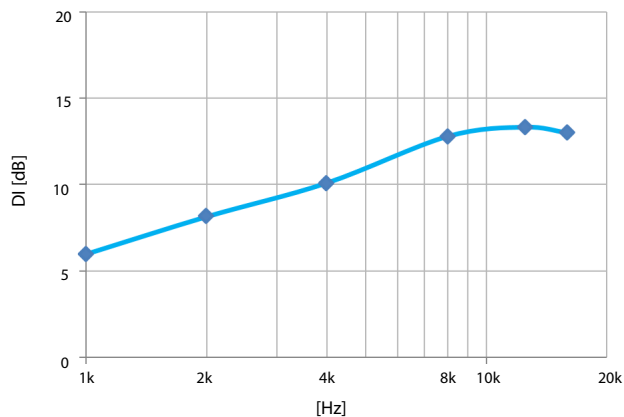

HORIZONTAL POLAR PATTERN

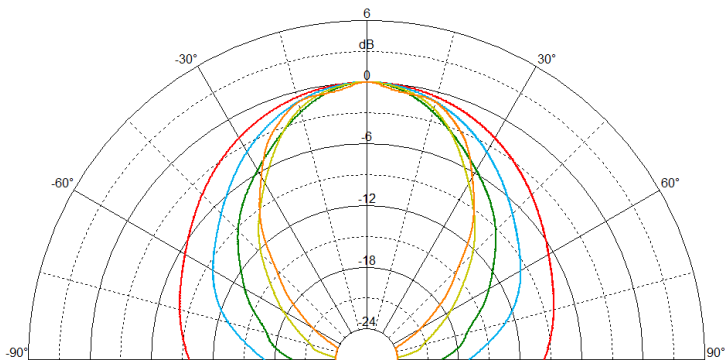

VERTICAL POLAR PATTERN

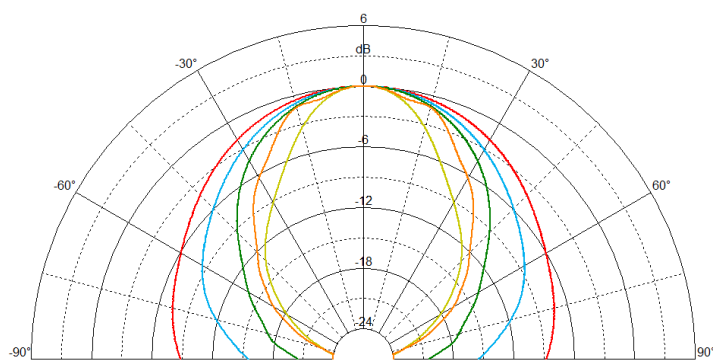

— 1 kHz — 2 kHz — 4 kHz — 8 kHz — 16 kHz